

Date: 1-16-26
Page: 1 Of: 8

Description: 20' x 10' x 8' L Shape Tradeshow Booth Wall
Customer:

Part Number:
Drawn by:

Moxitec
ALUMINUM FRAME COMPONENTS

Exploded View

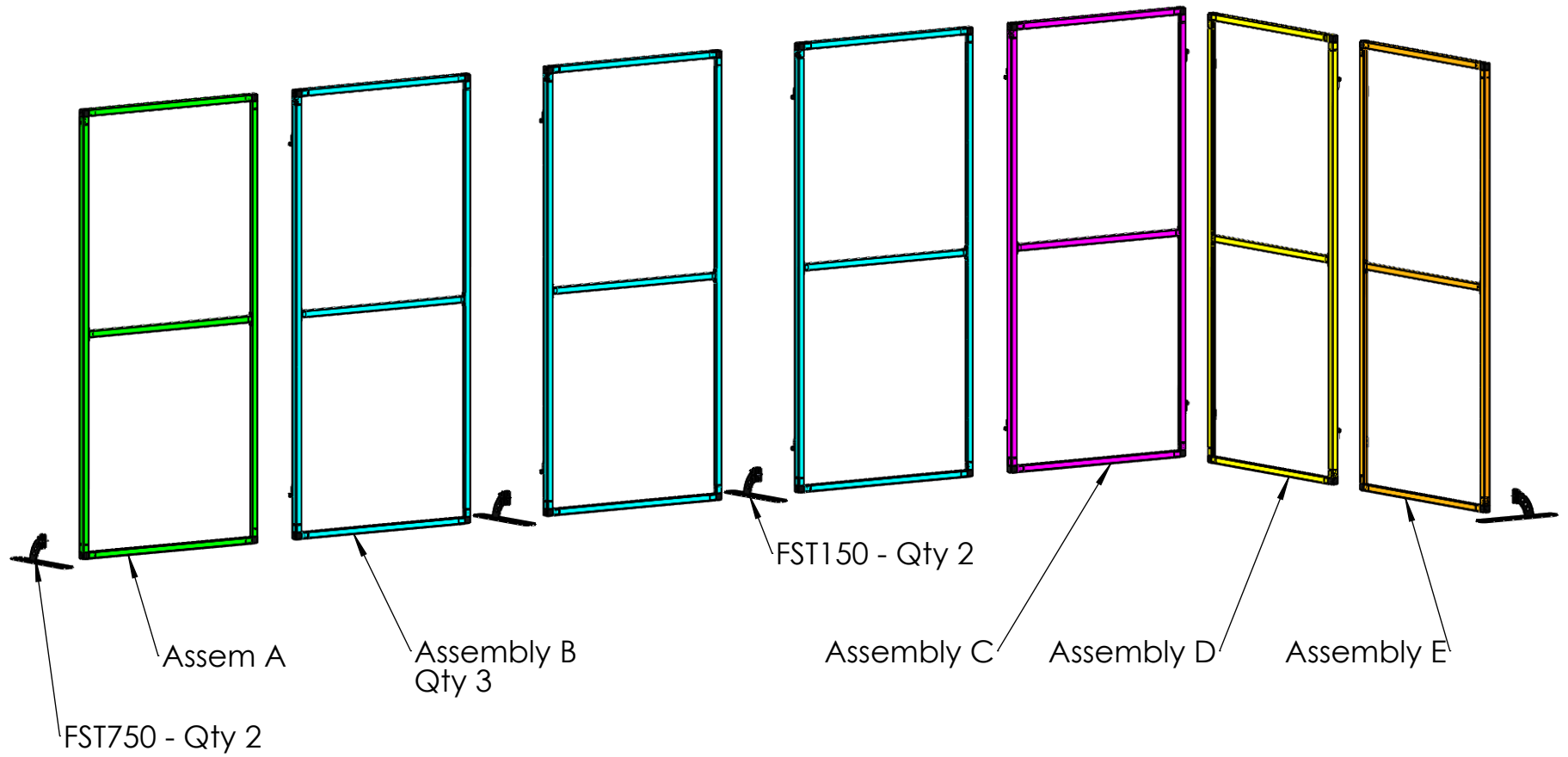

Assembly A

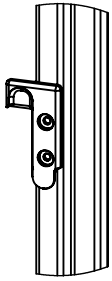

DETAIL A

SCALE 1 : 5

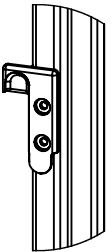
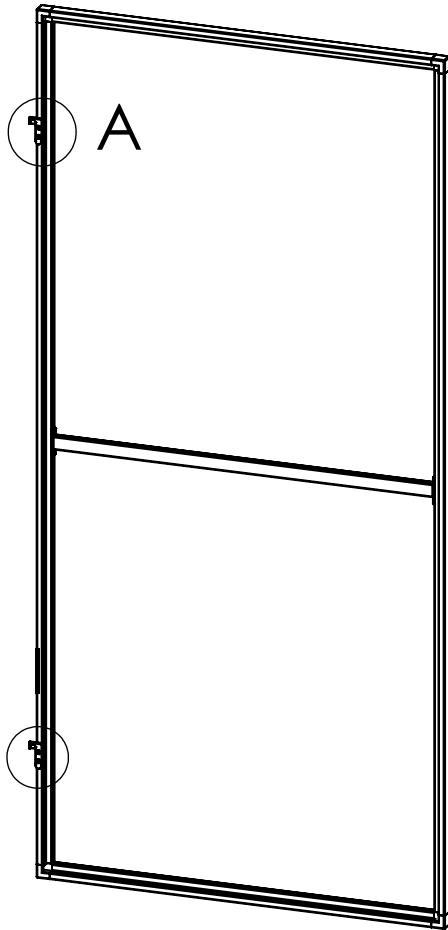

DETAIL I

SCALE 1 : 5

ITEM	QTY.	Part No.	DESCRIPTION	LENGTH (IN)	WIDTH (IN)
1	1				
2	2	TLA1-BL	L-Tube (Tight Fit - Black)	42.5	
3	2	TLA1-BL	L-Tube (Tight Fit - Black)	93	
4	1	TRA1-BL	R-Tube (Tight Fit - Black)	42.25	
5	4	JL2150	2-Way 90 degree corner joint		
6	2	JWT150	Winged T		
7	2	HBC180	Bear Clip 180 - Straight Clip		

Assembly B - Qty 3

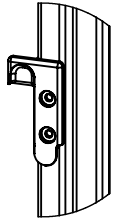

DETAIL B

SCALE 1 : 5

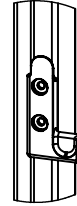
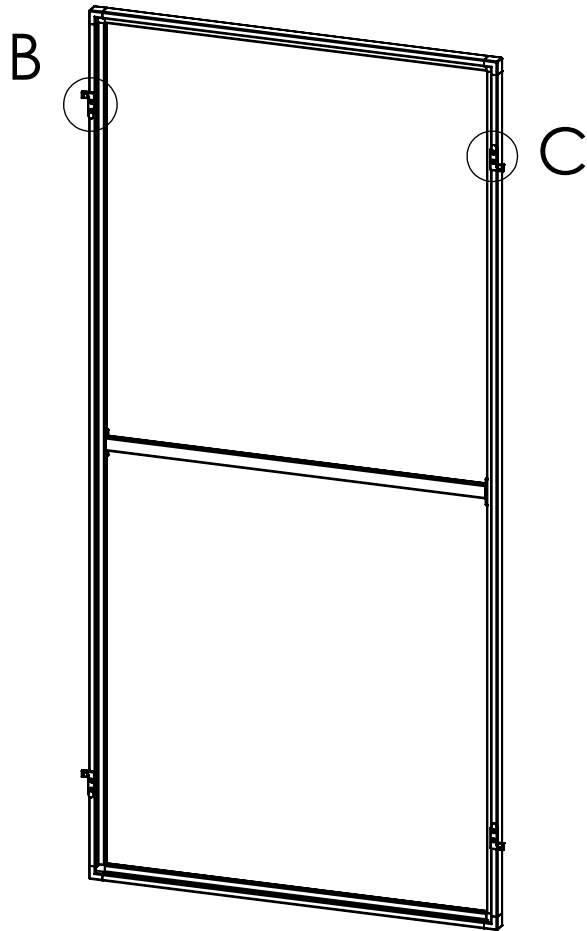

DETAIL C

SCALE 1 : 5

BOM Table

ITEM	QTY.	Part No.	DESCRIPTION	LENGTH (IN)	WIDTH (IN)
1	4	JL2150	2-Way 90 degree corner joint		
2	2	JWT150	Winged T		
3	4	HBC180	Bear Clip 180 - Straight Clip		
4	1				
5	2	TLA1-BL	L-Tube (Tight Fit - Black)	42.5	
6	2	TLA1-BL	L-Tube (Tight Fit - Black)	93	
7	1	TRA1-BL	R-Tube (Tight Fit - Black)	42.25	

Date: 1-16-26

Description: 20' x 10' x 8' L Shape Tradeshow Booth Wall

Part Number:

Moxitec
ALUMINUM FRAME COMPONENTS

Page: 4 Of: 8

Customer:

Drawn by:

Assembly C

Back

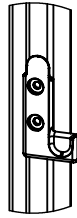
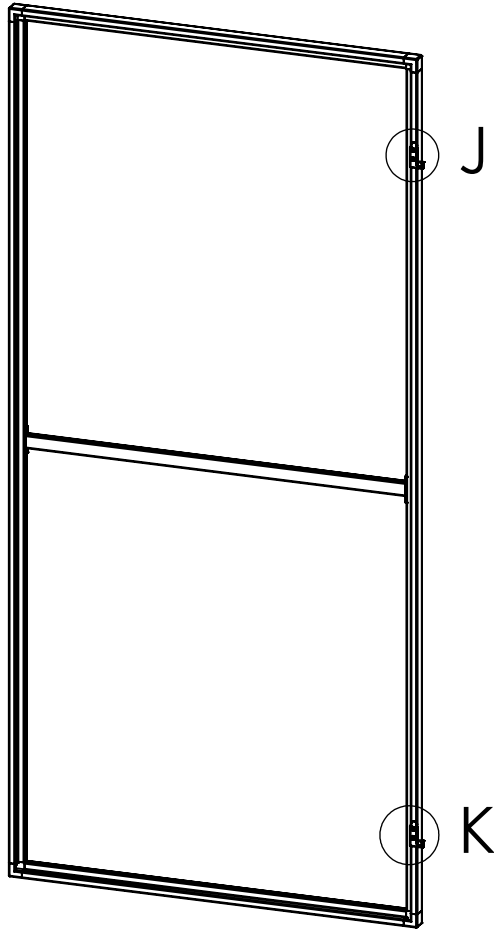

DETAIL J
SCALE 1 : 5

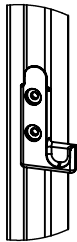

DETAIL K
SCALE 1 : 5

Front

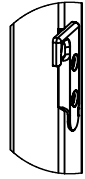
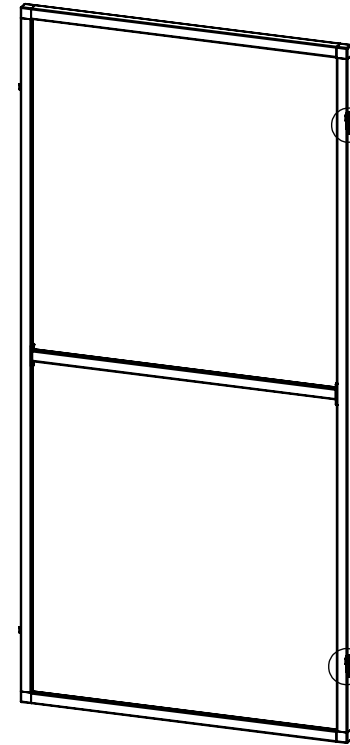

DETAIL L
SCALE 1 : 5

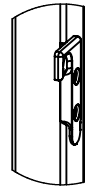

DETAIL M
SCALE 1 : 5

BOM Table

ITEM	QTY.	Part No.	DESCRIPTION	LENGTH (IN)	WIDTH (IN)
1	1				
2	2	TLA1-BL	L-Tube (Tight Fit - Black)	42.5	
3	2	TLA1-BL	L-Tube (Tight Fit - Black)	93	
4	1	TRA1-BL	R-Tube (Tight Fit - Black)	42.25	
5	4	JL2150	2-Way 90 degree corner joint		
6	2	JWT150	Winged T		
7	4	HBC180	Bear Clip 180 - Straight Clip		

Date: 1-16-26

Description: 20' x 10' x 8' L Shape Tradeshow Booth Wall

Part Number:

Page: 5 Of: 8

Customer:

Drawn by:

Moxitec
ALUMINUM FRAME COMPONENTS

Assembly D

Front

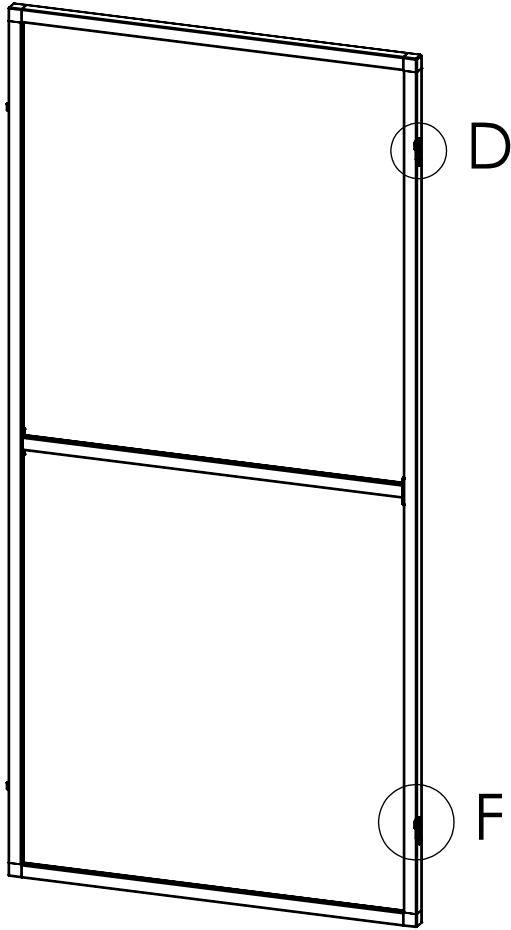

D

F

DETAIL D
SCALE 1 : 5

DETAIL F
SCALE 1 : 5

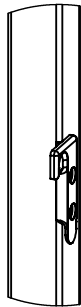
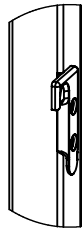

Back

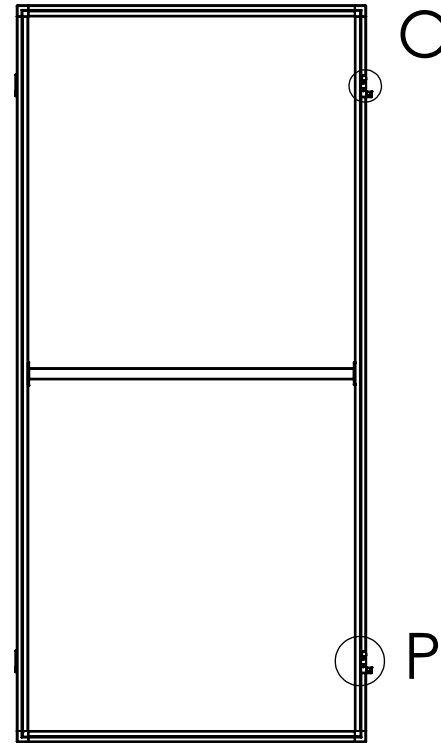

O

P

DETAIL O
SCALE 1 : 5

DETAIL P
SCALE 1 : 5

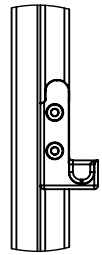
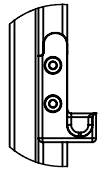

ITEM	QTY.	Part No.	DESCRIPTION	LENGTH (IN)	WIDTH (IN)
1	1				
2	2	TLA1-BL	L-Tube (Tight Fit - Black)	42.5	
3	2	TLA1-BL	L-Tube (Tight Fit - Black)	93	
4	1	TRA1-BL	R-Tube (Tight Fit - Black)	42.25	
5	4	JL2150	2-Way 90 degree corner joint		
6	2	JWT150	Winged T		
7	4	HBC180	Bear Clip 180 - Straight Clip		

Date: 1-16-26

Description: 20' x 10' x 8' L Shape Tradeshow Booth Wall

Part Number:

Page: 6 Of: 8

Customer:

Drawn by:

Moxitec
ALUMINUM FRAME COMPONENTS

Assembly E

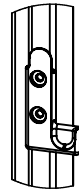
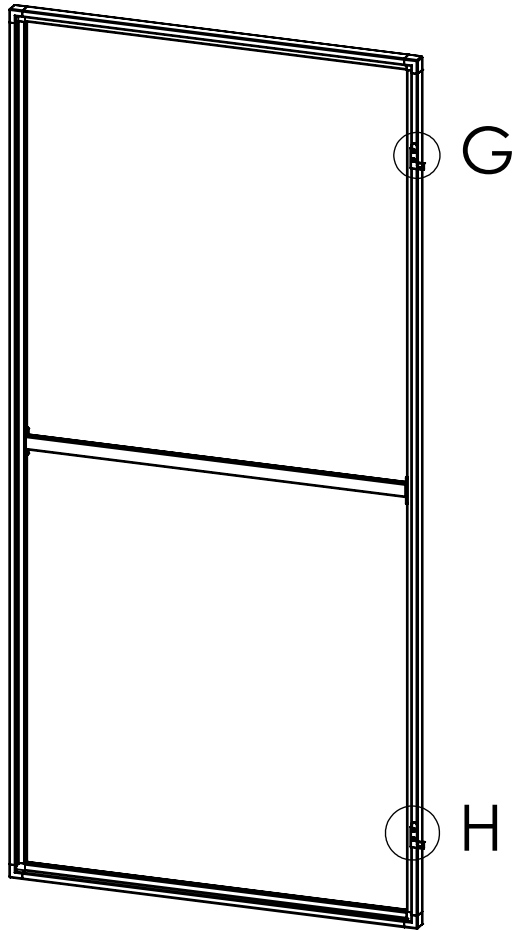

DETAIL G

SCALE 1 : 5

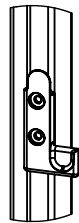

DETAIL H

SCALE 1 : 5

BOM Table

ITEM	QTY.	Part No.	DESCRIPTION	LENGTH (IN)	WIDTH (IN)
1	4	JL2150	2-Way 90 degree corner joint		
2	2	JWT150	Winged T		
3	2	HBC180	Bear Clip 180 - Straight Clip		
4	1				
5	2	TLA1-BL	L-Tube (Tight Fit - Black)	42.5	
6	2	TLA1-BL	L-Tube (Tight Fit - Black)	93	
7	1	TRA1-BL	R-Tube (Tight Fit - Black)	42.25	

Date: 1-16-26

Description: 20' x 10' x 8' L Shape Tradeshow Booth Wall

Part Number:

Page: 7 Of: 8

Customer:

Drawn by:

Moxitec
ALUMINUM FRAME COMPONENTS

PPHS10-625

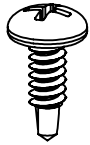

Winged T - JWT150

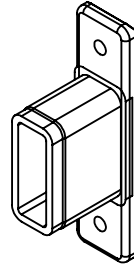

Bear Clip 180 Assembly

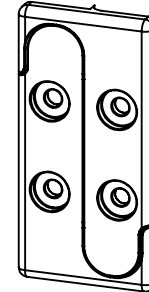

2 Way - JL2150

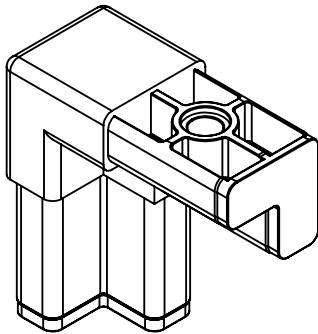

FST150 (with lock pin)

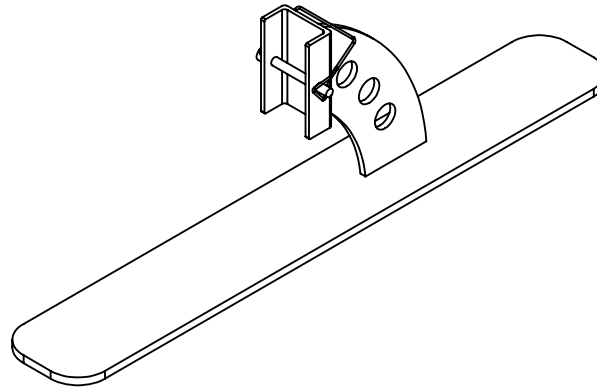

FST750 (with lock pin)

