

Chicken Coop

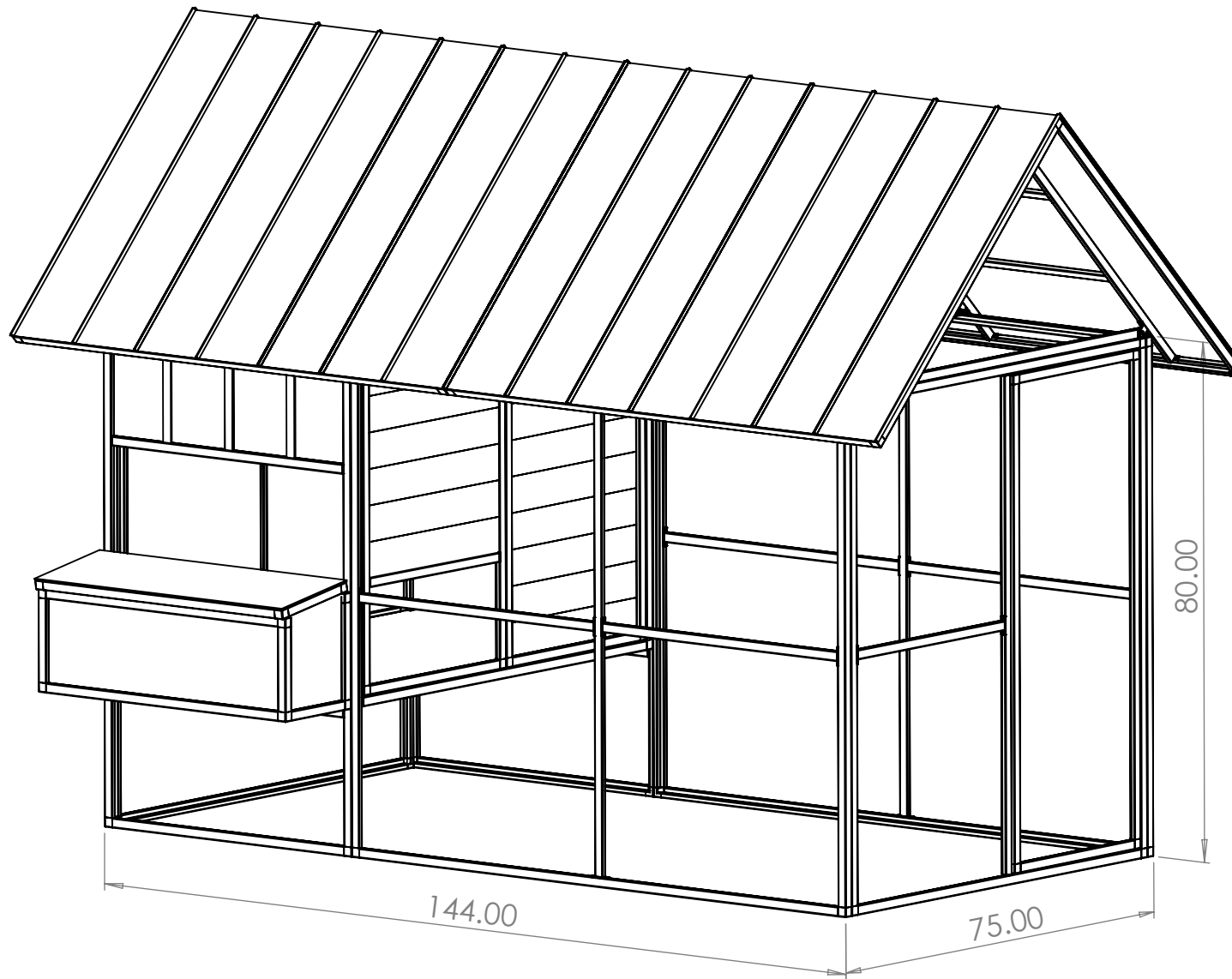

Note: Drawing specs are for tubing lengths and connecting joints.
Some material not specified.

Date: xx-xx-xx

Description:

Part Number:

Page: 1 Of: 28

Customer:

Drawn by:

MOXI ALUMINUM FRAME
COMPONENTS

5

4

3

2

1

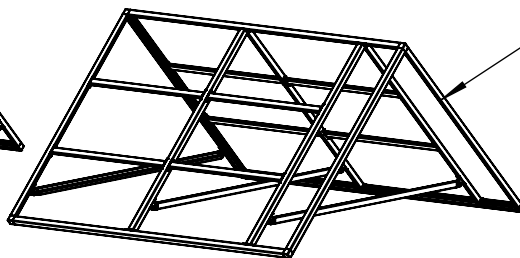
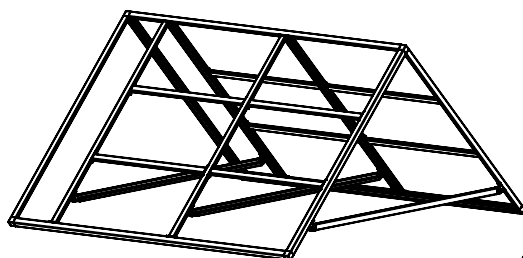
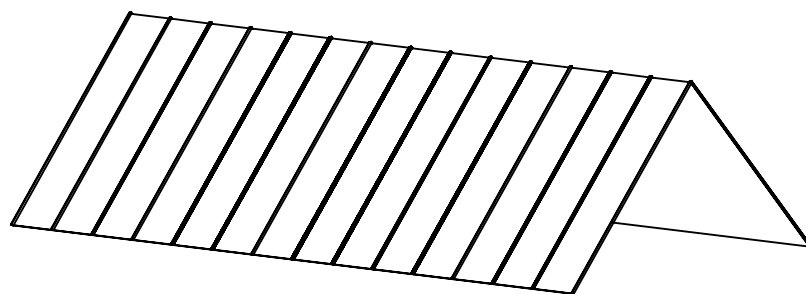

Roof Frame
Qty 2

Chicken House

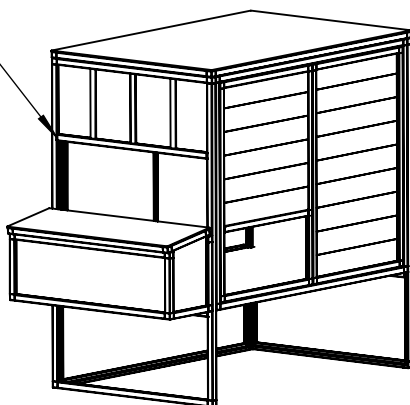

Chicken Run

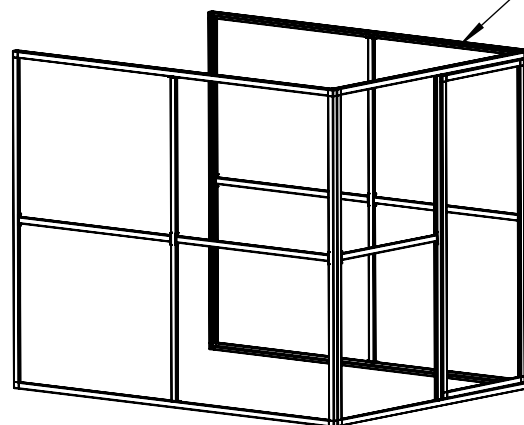

Chicken House

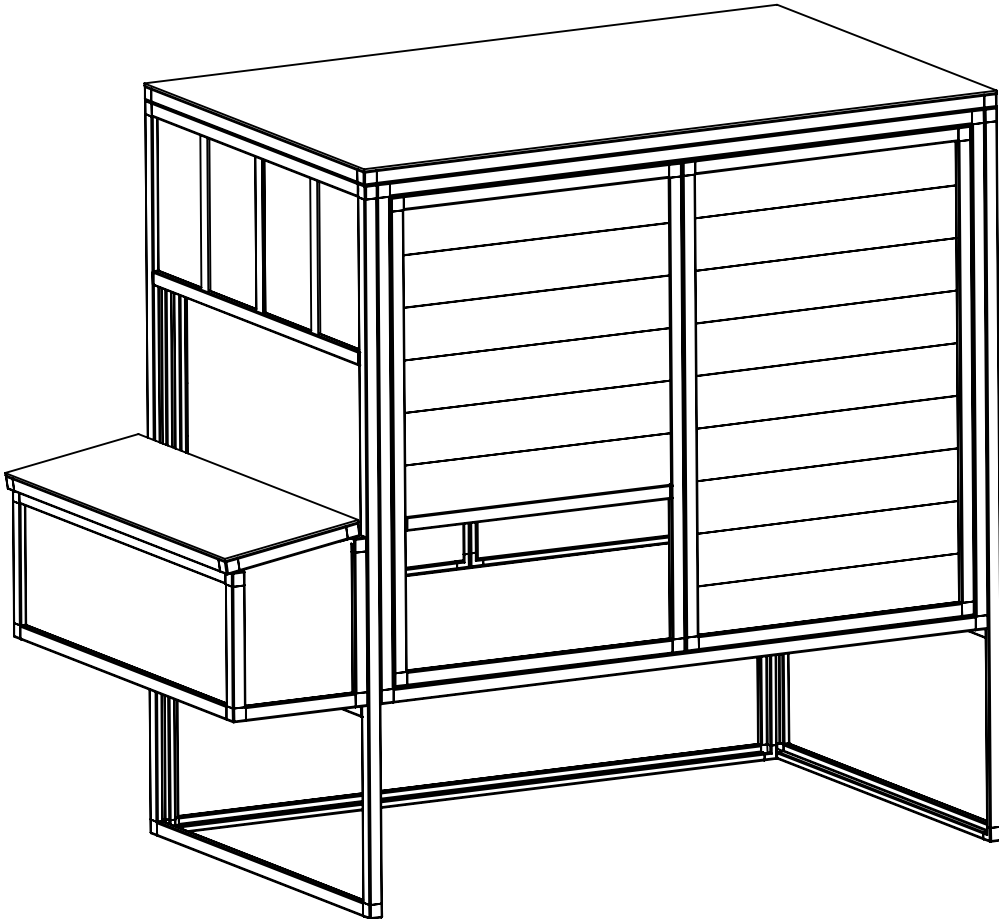

Date: xx-xx-xx

Description:

Part Number:

MOXI ALUMINUM FRAME
COMPONENTS

Page: 3 Of: 28

Customer:

Drawn by:

5

4

3

2

1

Chicken House - Exploded View

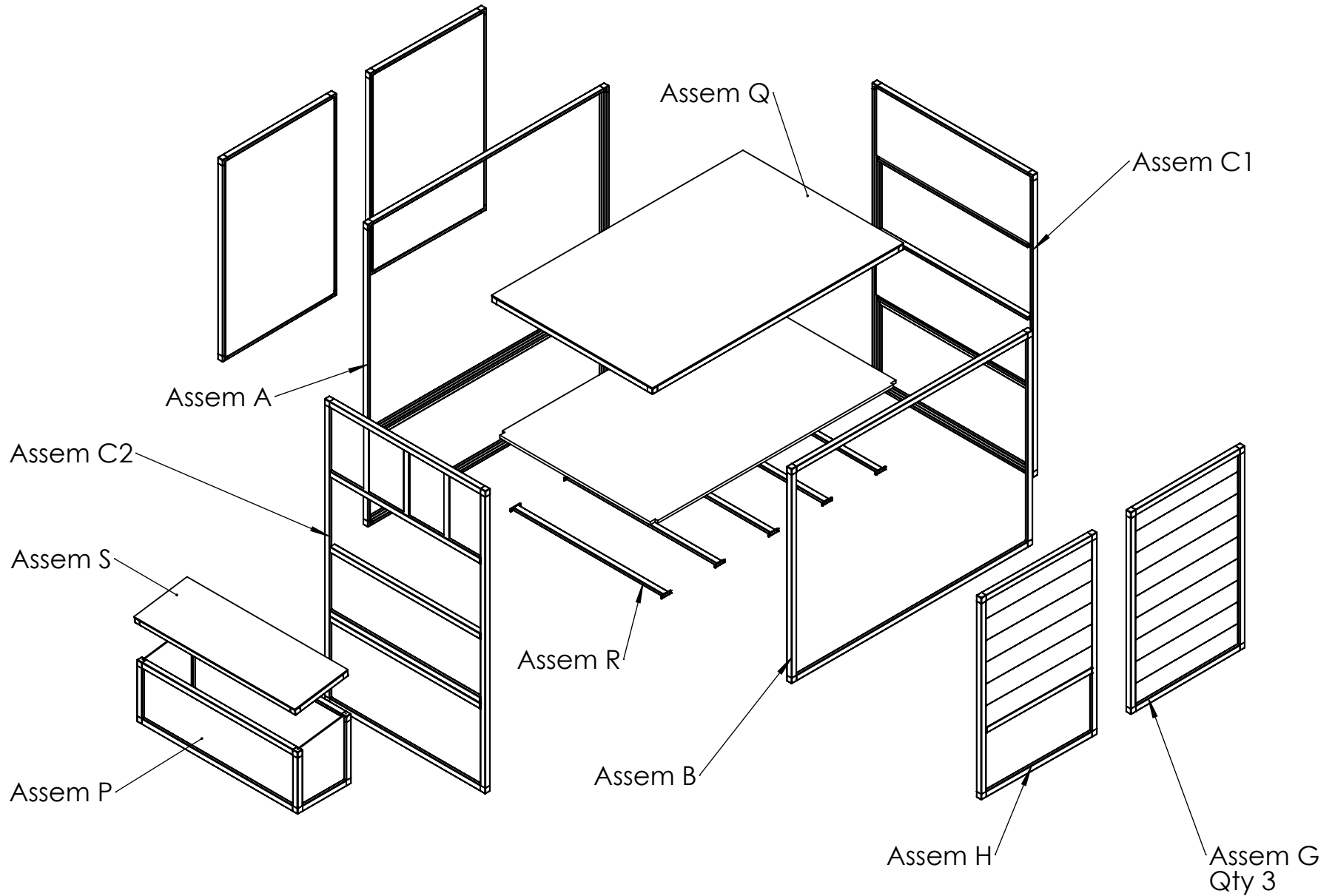

Date: xx-xx-xx
Page: 4 Of: 28

Description:
Customer:

Part Number:
Drawn by:

MOXI ALUMINUM FRAME
COMPONENTS

5

4

3

2

1

Assem A

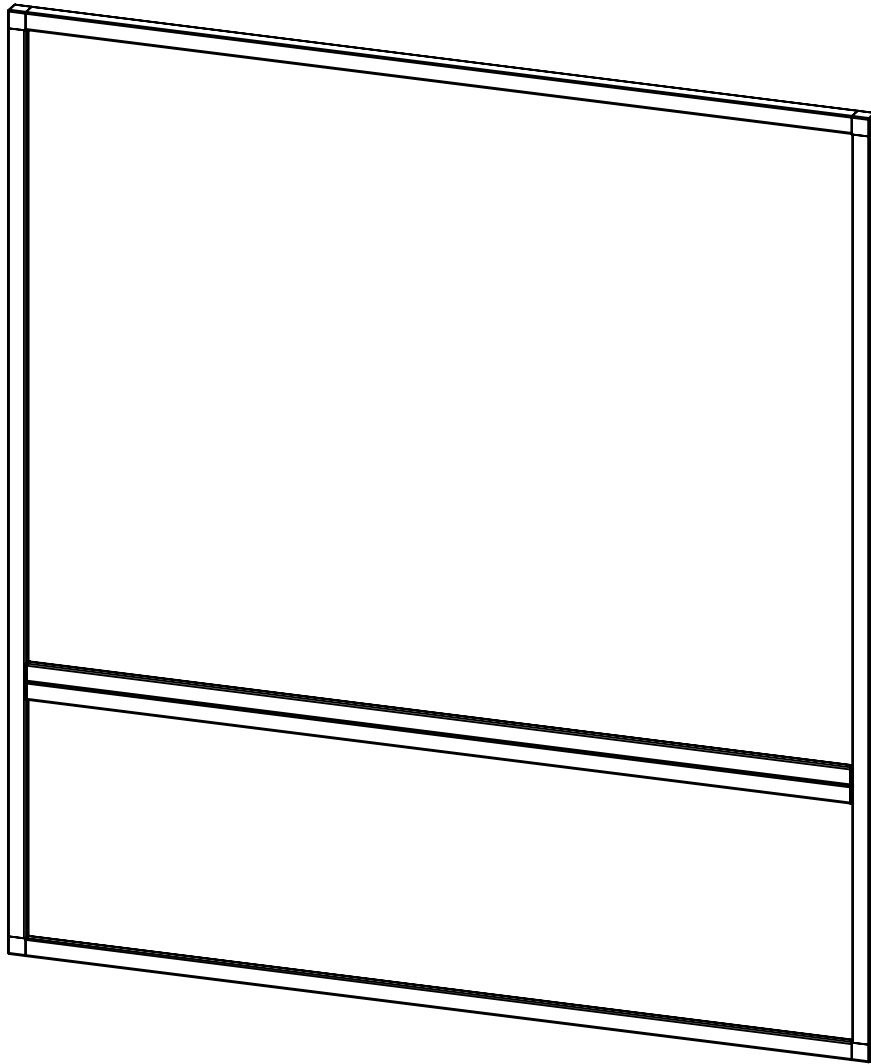

ITEM	QTY.	Part No.	DESCRIPTION	LENGTH (IN)	WIDTH (IN)
1	1				
2	2	TLA1-BL	L-Tube (Tight Fit - Black)	69	
3	1	TRA1-BL	R-Tube (Tight Fit - Black)	68.75	
4	2	TLA1-BL	L-Tube (Tight Fit - Black)	75.25	
5	1	TLA1-BL	L-Tube (Tight Fit - Black)	68.75	
6	4	JL2150	2-Way 90 degree corner joint		
7	4	JFT150	Flush T		

Assem B

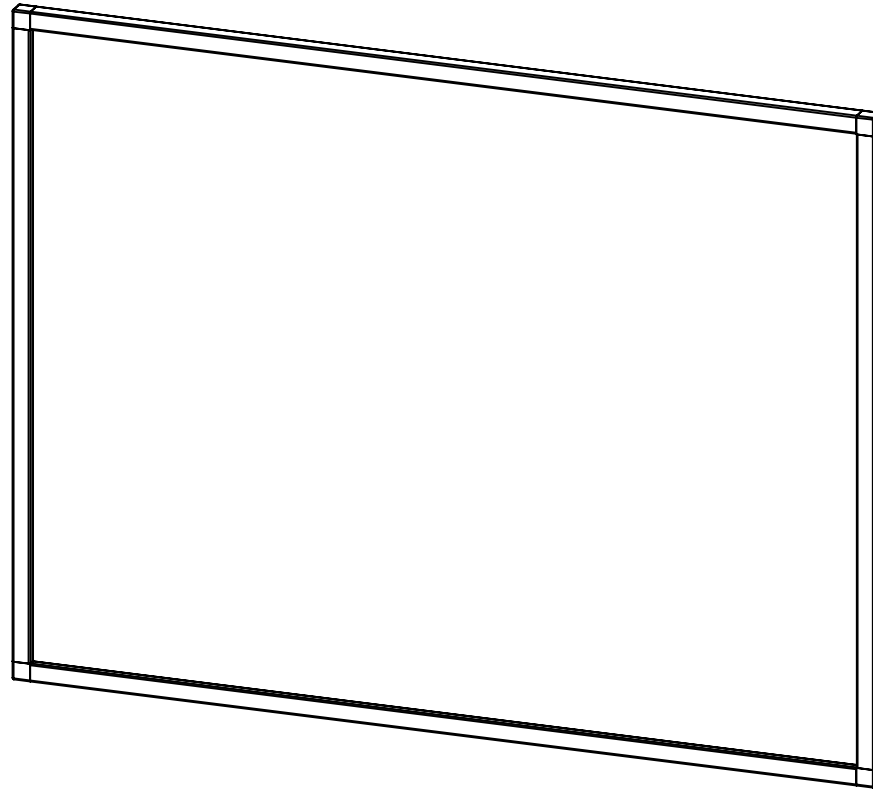

ITEM	QTY.	Part No.	DESCRIPTION	LENGTH (IN)	WIDTH (IN)
1	1				
2	2	TLA1-BL	L-Tube (Tight Fit - Black)	69	
3	2	TLA1-BL	L-Tube (Tight Fit - Black)	52.5	
4	4	JL2150	2-Way 90 degree corner joint		

Date: xx-xx-xx

Description:

Page: 6 Of: 28

Customer:

Part Number:

Drawn by:

MOXI ALUMINUM FRAME COMPONENTS

Assem C1

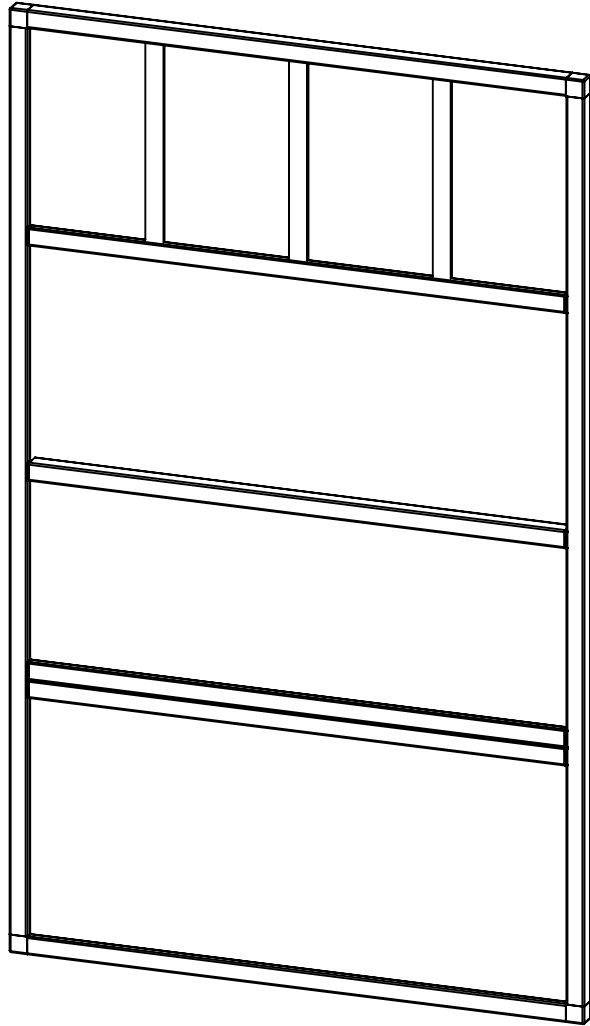

ITEM	QTY.	Part No.	DESCRIPTION	LENGTH (IN)	WIDTH (IN)
1	1				
2	2	TLA1-BL	L-Tube (Tight Fit - Black)	45	
3	2	TLA1-BL	L-Tube (Tight Fit - Black)	75.25	
4	3	TLA1-BL	L-Tube (Tight Fit - Black)	44.75	
5	1	TRA1-BL	R-Tube (Tight Fit - Black)	44.75	
6	4	JL2150	2-Way 90 degree corner joint		
7	8	JFT150	Flush T		
8	1		Panel (Top)		
9	1	Panel	Panel (Middle)	17.875	46.375
10	4				
11	1	Panel	Panel (middle)	16.440	46.375

Assem C2

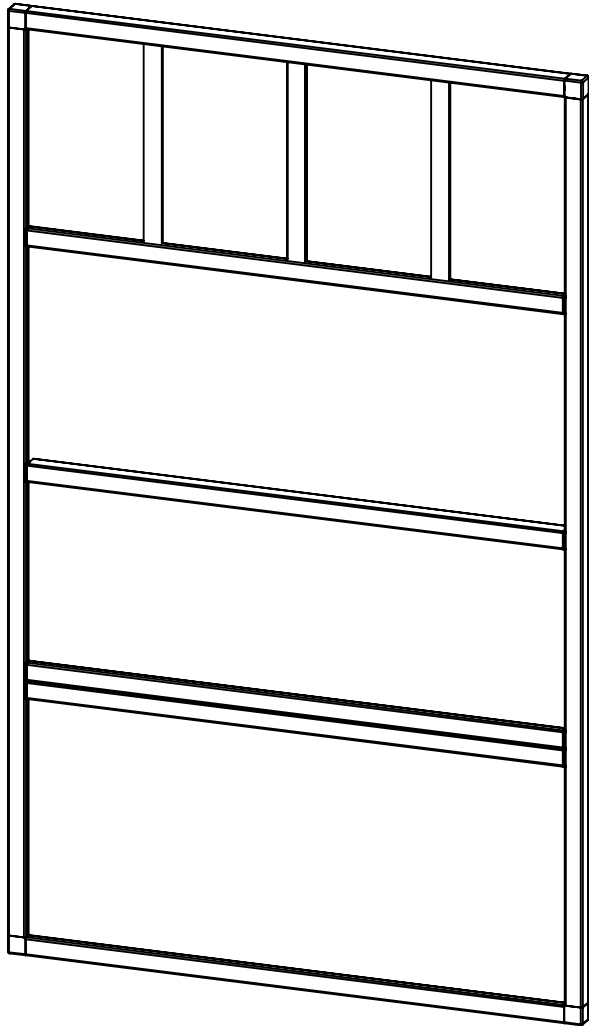

ITEM	QTY.	Part No.	DESCRIPTION	LENGTH (IN)	WIDTH (IN)
1	4	JL2150	2-Way 90 degree corner joint		
2	8	JFT150	Flush T		
3	1				
4	2	TLA1-BL	L-Tube (Tight Fit - Black)	45	
5	1	TRA1-BL	R-Tube (Tight Fit - Black)	44.75	
6	2	TLA1-BL	L-Tube (Tight Fit - Black)	75.25	
7	3	TLA1-BL	L-Tube (Tight Fit - Black)	44.75	
8	1	Panel	Panel (Middle)	17.875	46.375

Assem G - Qty 3

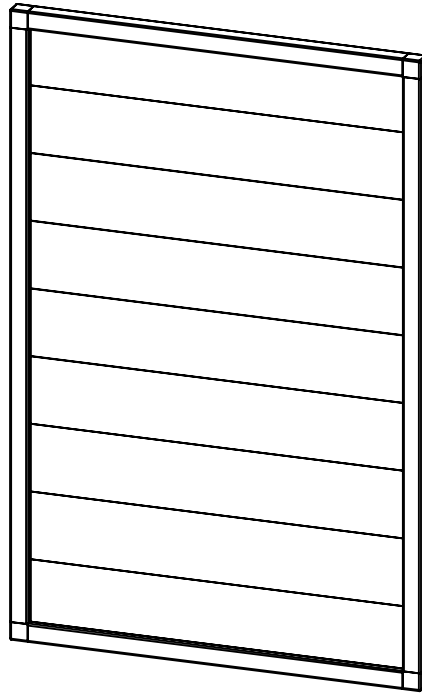

ITEM	QTY.	Part No.	DESCRIPTION	LENGTH (IN)	WIDTH (IN)
1	1				
2	2	TLA1-BL	L-Tube (Tight Fit - Black)	31.313	
3	2	TLA1-BL	L-Tube (Tight Fit - Black)	49.25	
4	4	JL2150	2-Way 90 degree corner joint		
5	1	Panel	Panel (Door)	50.625	32.688

Assem H

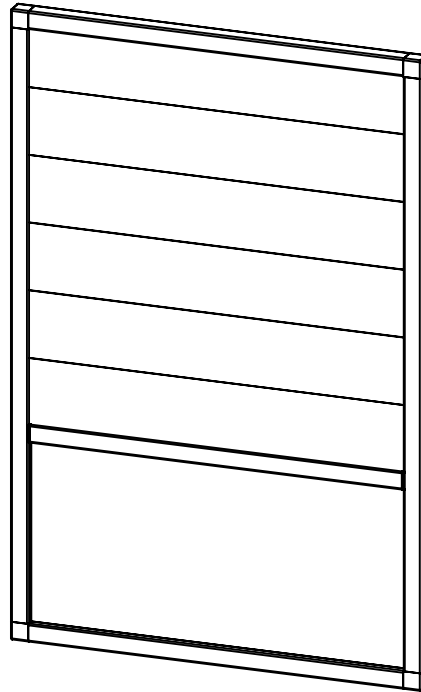

ITEM	QTY.	Part No.	DESCRIPTION	LENGTH (IN)	WIDTH (IN)
1	4	JL2150	2-Way 90 degree corner joint		
2	2	JFT150	Flush T		
3	1				
4	2	TLA1-BL	L-Tube (Tight Fit - Black)	31.313	
5	2	TLA1-BL	L-Tube (Tight Fit - Black)	49.25	
6	1	TLA1-BL	L-Tube (Tight Fit - Black)	31.063	
7	1	Panel	Panel (Door)	34.125	32.688

Assem P

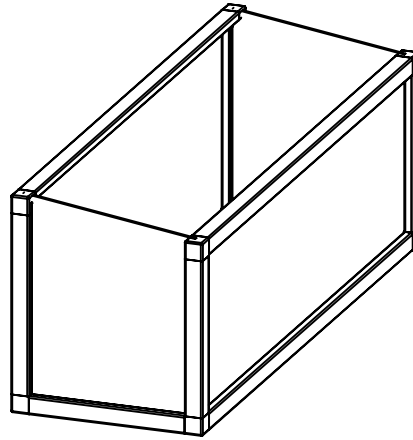

ITEM	QTY.	Part No.	DESCRIPTION	LENGTH (IN)	WIDTH (IN)
1	1				
2	2	TLA1-BL	L-Tube (Tight Fit - Black)	15	
3	4	TLA1-BL	L-Tube (Tight Fit - Black)	13	
4	4	TLA1-BL	L-Tube (Tight Fit - Black)	45	
5	4	JL2150	2-Way 90 degree corner joint		
6	4	JL3150	3-Way Corner Joint		
7	1	Panel	Panel (Front)	14.250	46.250
8	2				
9	1	Panel	Panel (Sides)	45.938	14.375

Assem Q

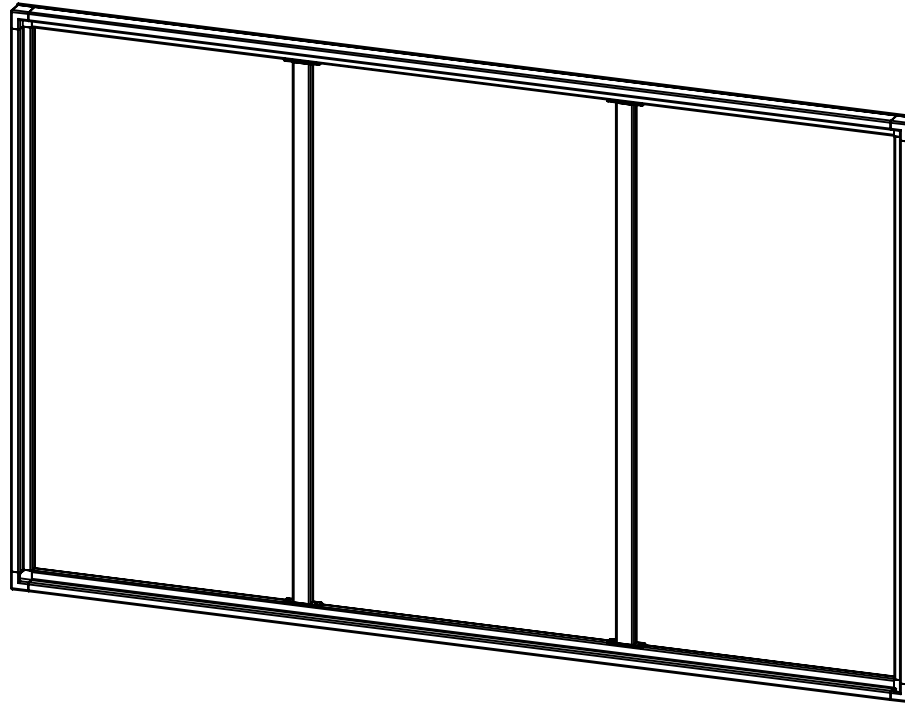

ITEM	QTY.	Part No.	DESCRIPTION	LENGTH (IN)	WIDTH (IN)
1	1				
2	2	TLA1-BL	L-Tube (Tight Fit - Black)	72	
3	2	TLA1-BL	L-Tube (Tight Fit - Black)	45	
4	2	TRA1-BL	R-Tube (Tight Fit - Black)	44.75	
5	4	JL2150	2-Way 90 degree corner joint		
6	4	JWT150	Winged T		
7	1	Panel	Panel (Top)	75	48

Date: xx-xx-xx
Page: 12 Of: 28

Description:
Customer:

Part Number:
Drawn by:

MOXI ALUMINUM FRAME
COMPONENTS

Assem R - Qty 5

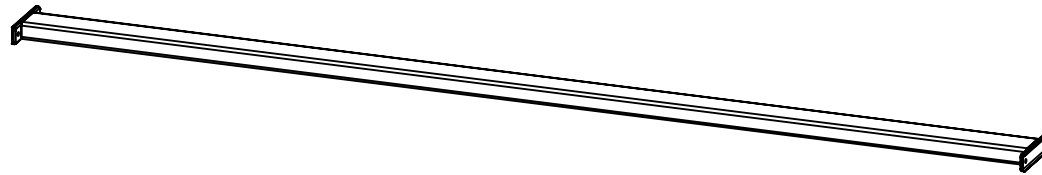

ITEM	QTY.	Part No.	DESCRIPTION	LENGTH (IN)	WIDTH (IN)
1	1				
2	1	TRA1-BL	R-Tube (Tight Fit - Black)	44.75	
3	2	JWT150	Winged T		

Assem S

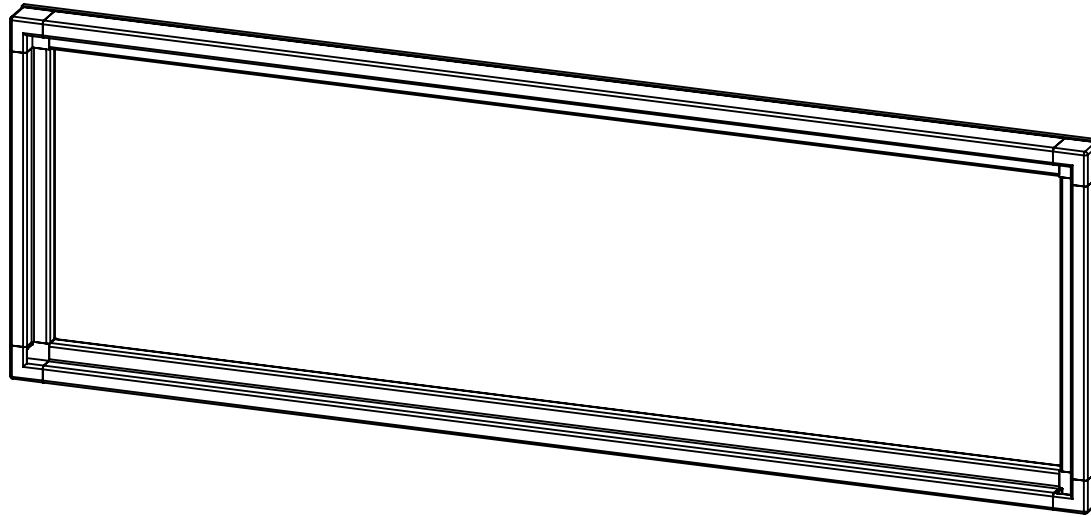

ITEM	QTY.	Part No.	DESCRIPTION	LENGTH (IN)	WIDTH (IN)
1	1				
2	2	TLA1-BL	L-Tube (Tight Fit - Black)	45	
3	2	TLA1-BL	L-Tube (Tight Fit - Black)	13	
4	4	JL2150	2-Way 90 degree corner joint		
5	1	Panel	Panel (Top)	48.000	16.000

Chicken Run

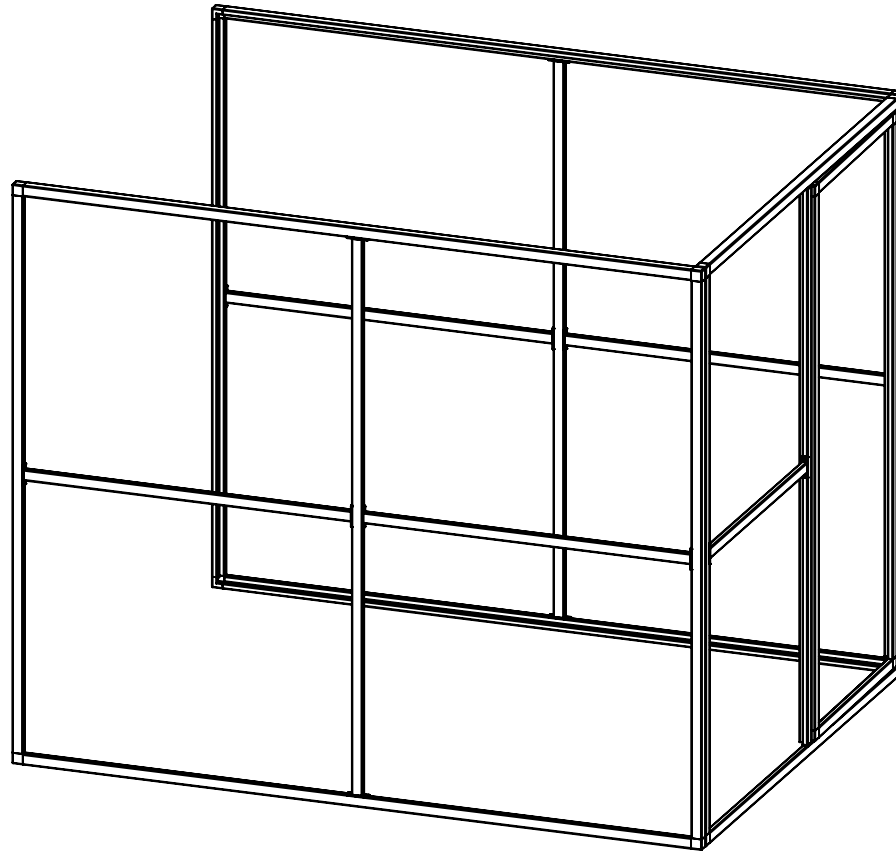

Chicken Run - Exploded View

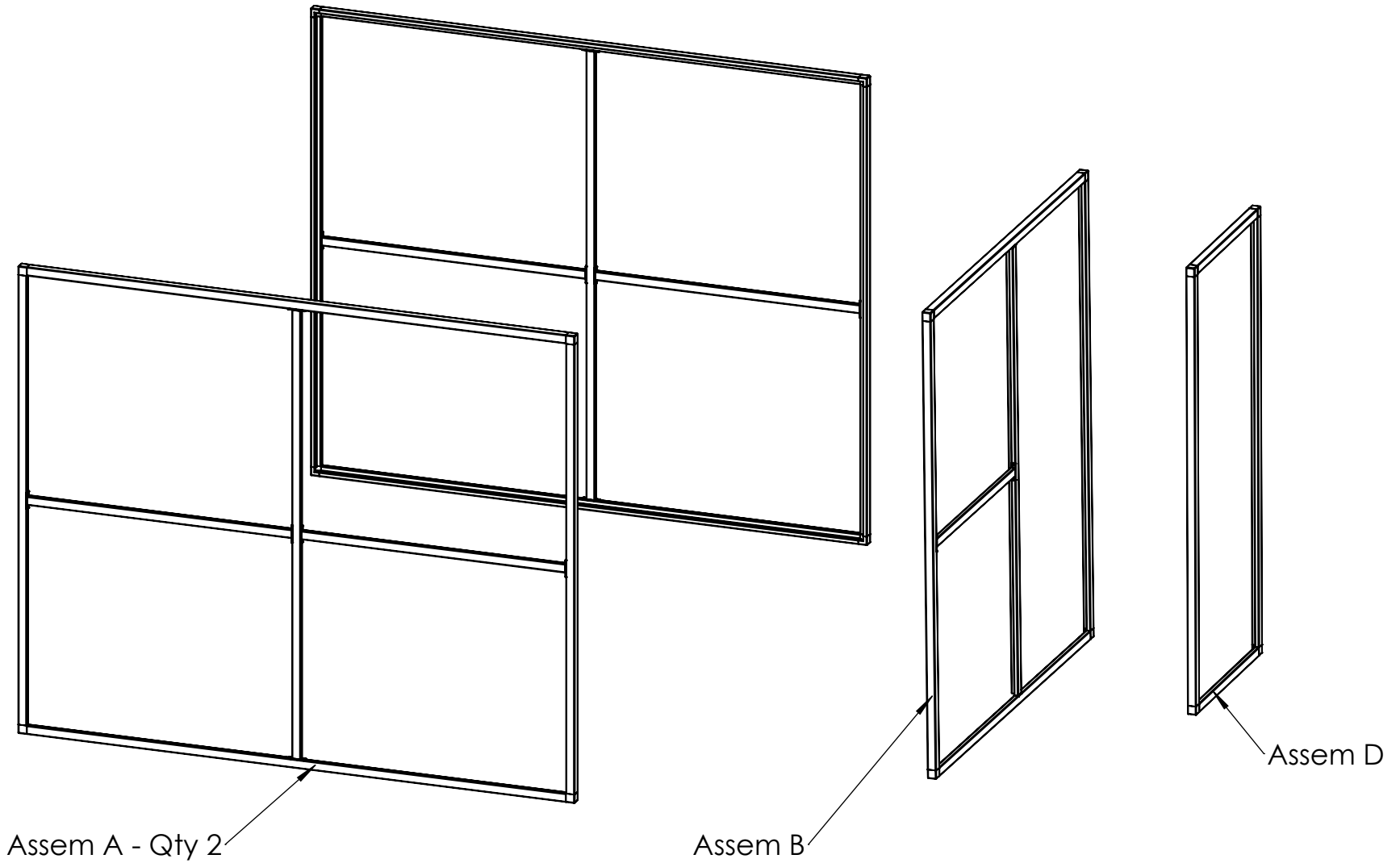

Assem A - Qty 2

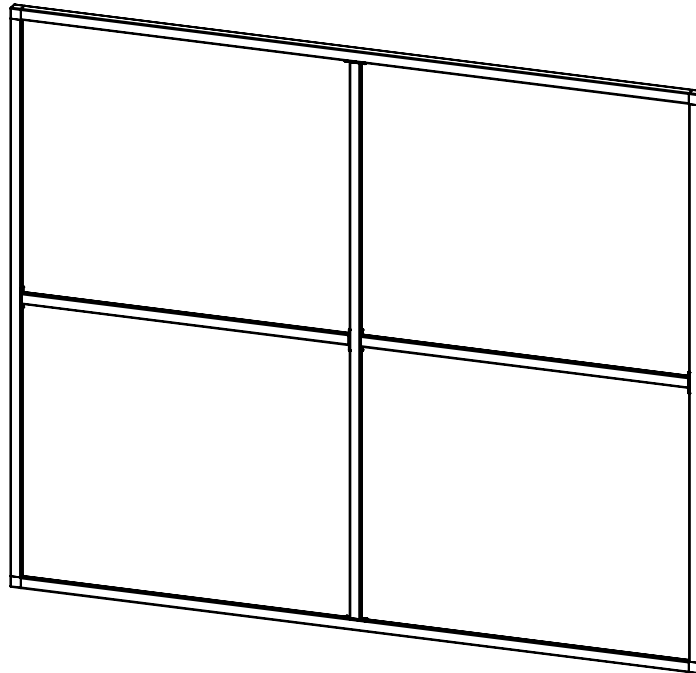

ITEM	QTY.	Part No.	DESCRIPTION	LENGTH (IN)	WIDTH (IN)
1	1				
2	2	TLA1-BL	L-Tube (Tight Fit - Black)	93	
3	2	TLA1-BL	L-Tube (Tight Fit - Black)	77	
4	1	TRA1-BL	R-Tube (Tight Fit - Black)	76.75	
5	2	TRA1-BL	R-Tube (Tight Fit - Black)	45.5	
6	4	JL2150	2-Way 90 degree corner joint		
7	6	JWT150	Winged T		

Assem B

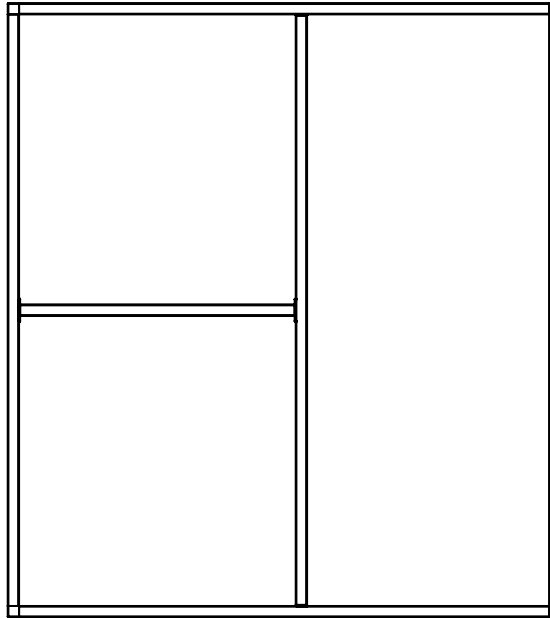

ITEM	QTY.	Part No.	DESCRIPTION	LENGTH (IN)	WIDTH (IN)
1	1				
2	2	TLA1-BL	L-Tube (Tight Fit - Black)	69	
3	1	TRA1-BL	R-Tube (Tight Fit - Black)	35.75	
4	2	TLA1-BL	L-Tube (Tight Fit - Black)	77	
5	1	TLA1-BL	L-Tube (Tight Fit - Black)	76.75	
6	4	JL2150	2-Way 90 degree corner joint		
7	2	JFT150	Flush T		
8	2	JWT150	Winged T		

Date: xx-xx-xx
Page: 18 Of: 28

Description:
Customer:

Part Number:
Drawn by:

MOXI ALUMINUM FRAME
COMPONENTS

Assem D

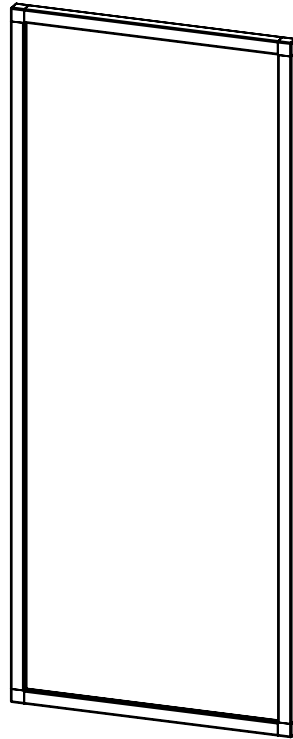

ITEM	QTY.	Part No.	DESCRIPTION	LENGTH (IN)	WIDTH (IN)
1	1				
2	2	TLA1-BL	L-Tube (Tight Fit - Black)	28.25	
3	2	TLA1-BL	L-Tube (Tight Fit - Black)	73.75	
4	4	JL2150	2-Way 90 degree corner joint		

Roof Frame - Qty 2

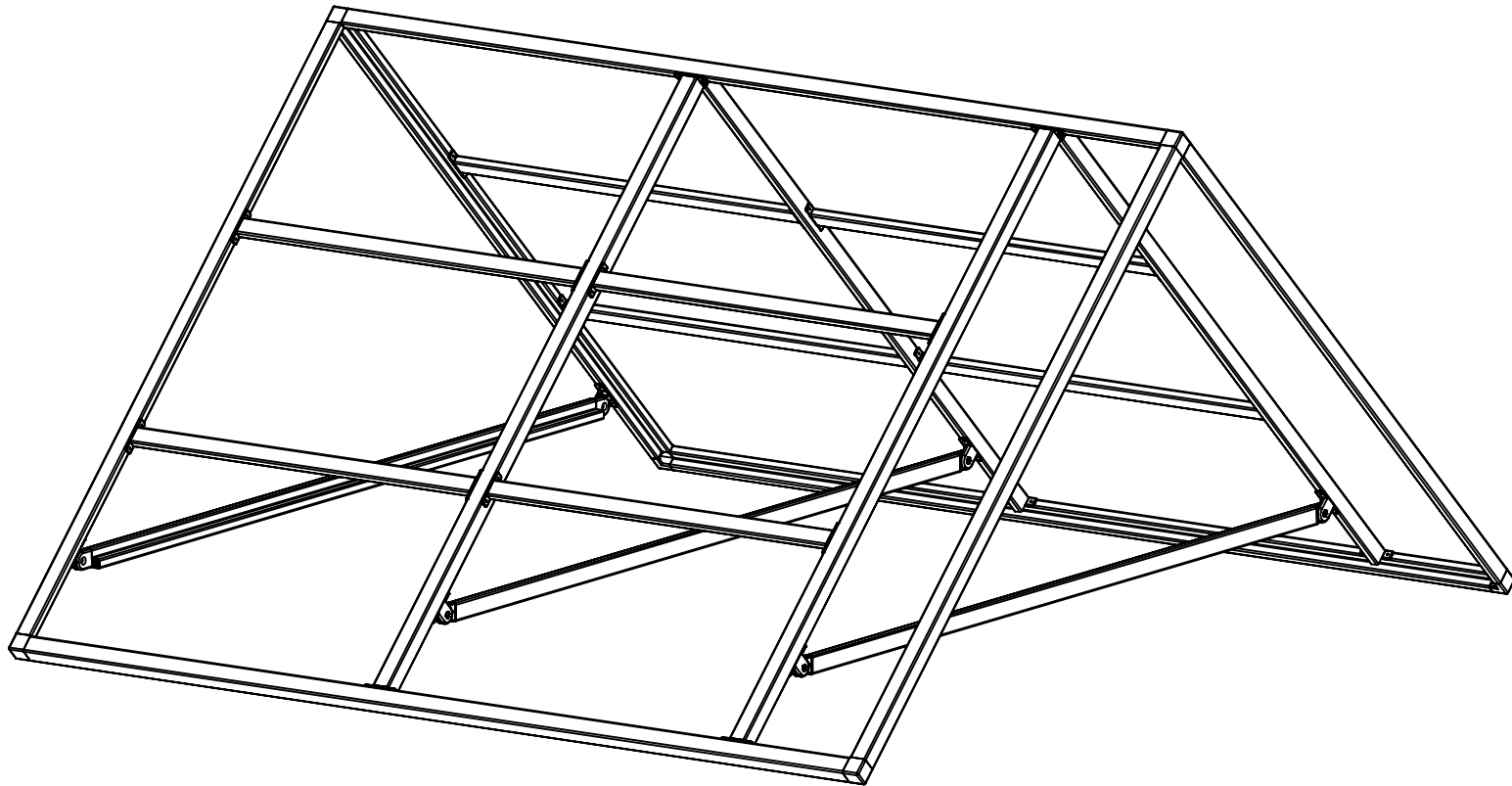

Roof Frame - Exploded View

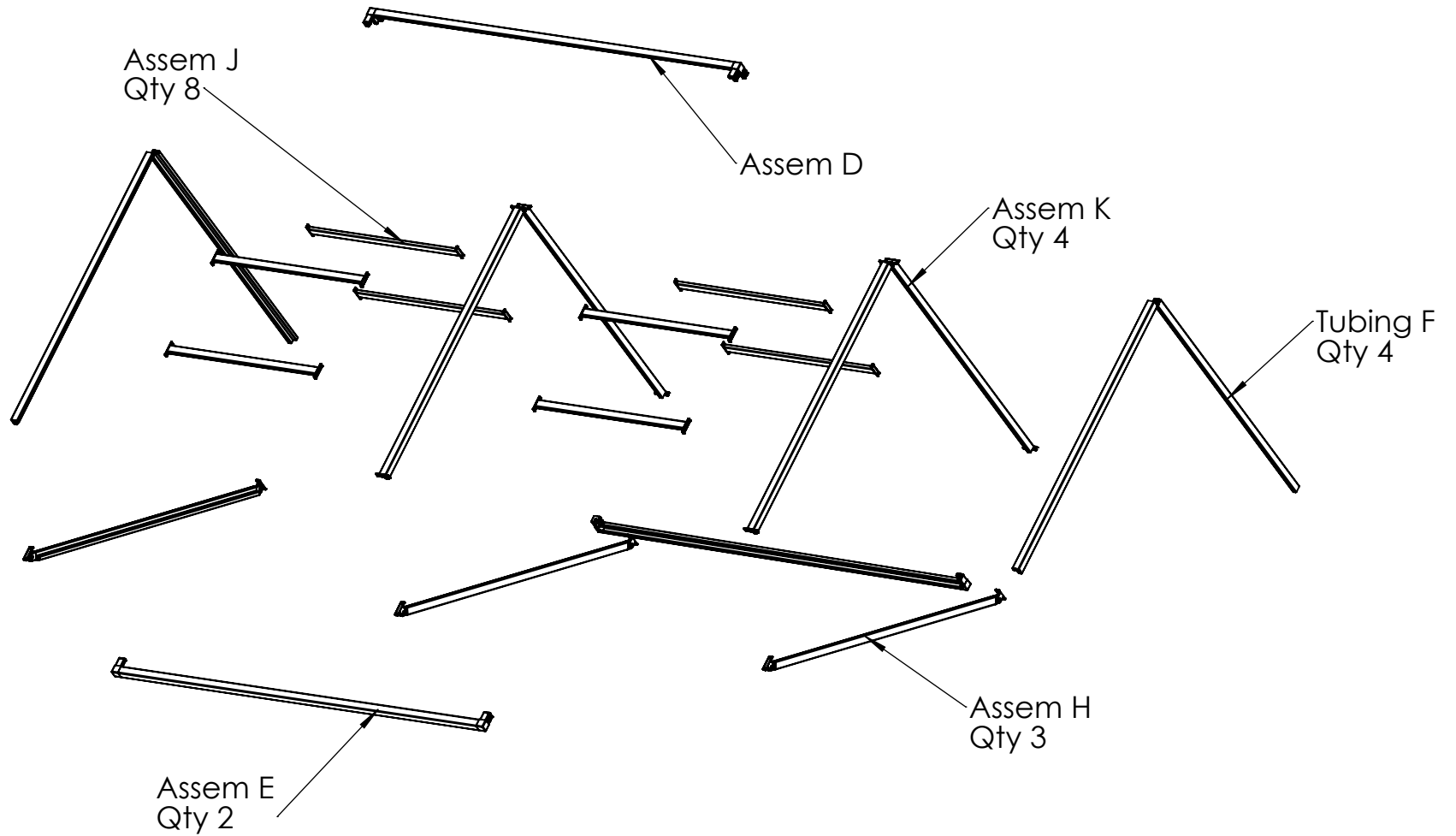

Assem D

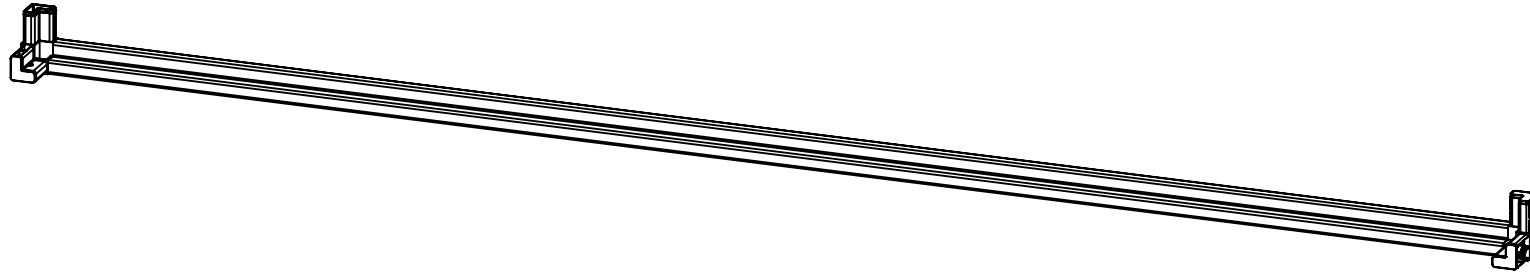

ITEM	QTY.	Part No.	DESCRIPTION	LENGTH (IN)	WIDTH (IN)
1	1				
2	1	TLA1-BL	L-Tube (Tight Fit - Black)	81	
3	2	JL3150	3-Way Corner Joint		

Assem E - Qty 2

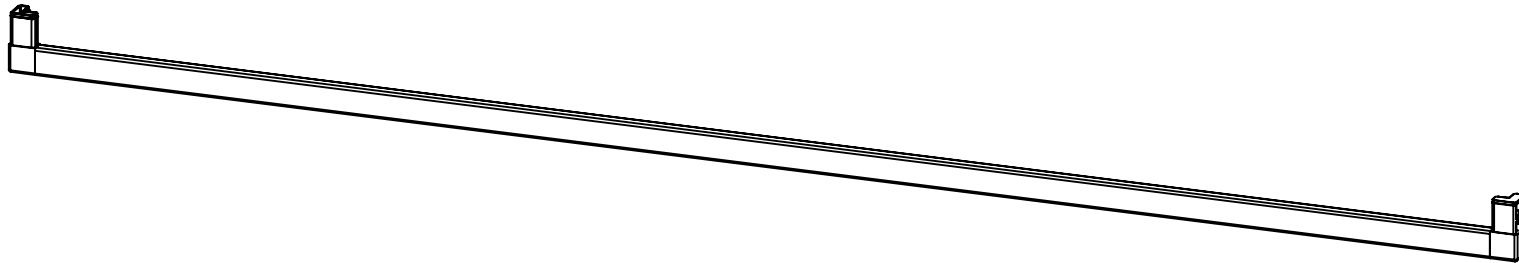

ITEM	QTY.	Part No.	DESCRIPTION	LENGTH (IN)	WIDTH (IN)
1	1				
2	1	TLA1-BL	L-Tube (Tight Fit - Black)	81	
3	2	JL2150	2-Way 90 degree corner joint		

Tubing F - Qty 4

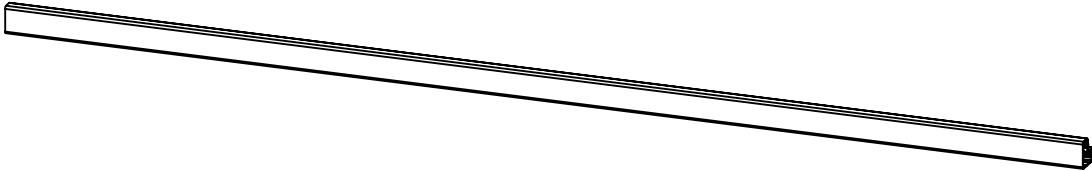

ITEM	QTY.	Part No.	DESCRIPTION	LENGTH (IN)	WIDTH (IN)
1	1				
2	1	TLA1-BL	L-Tube (Tight Fit - Black)	60	

Assem H - Qty 3

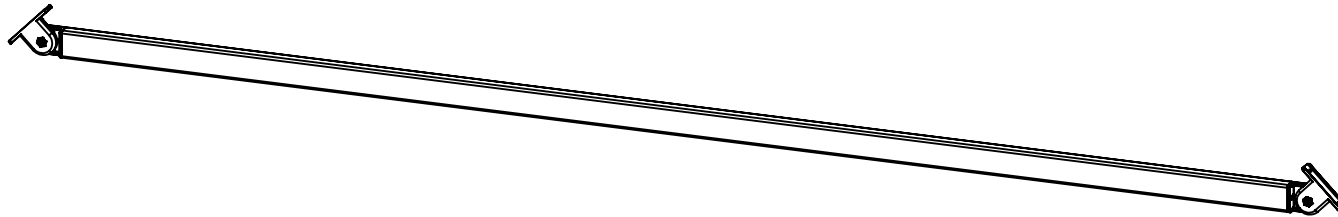

ITEM	QTY.	Part No.	DESCRIPTION	LENGTH (IN)	WIDTH (IN)
1	1				
2	1	TLA1-BL	L-Tube (Tight Fit - Black)	68.25	
3	2	JPAC150	Pivot Arm Chamfered		
4	2	JPB150	Pivot Base		

Assem J - Qty 8

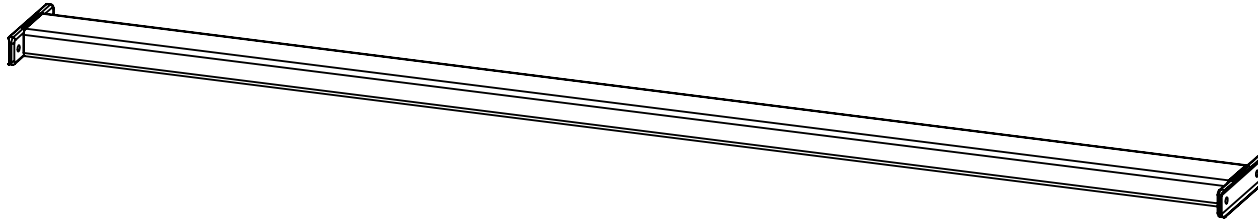

ITEM	QTY.	Part No.	DESCRIPTION	LENGTH (IN)	WIDTH (IN)
1	1				
2	1	TRA1-BL	R-Tube (Tight Fit - Black)	33.5	
3	2	JWT150	Winged T		

Assem K - Qty 4

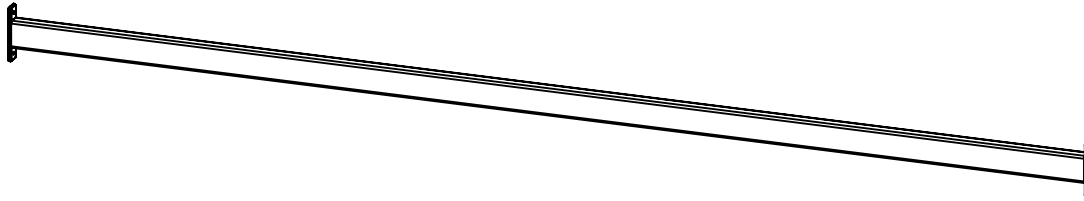

ITEM	QTY.	Part No.	DESCRIPTION	LENGTH (IN)	WIDTH (IN)
1	1				
2	1	TLA1-BL	L-Tube (Tight Fit - Black)	59.75	
3	2	JWT150	Winged T		

PPHS10-625



Z Clip - HZC10

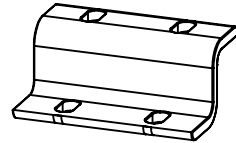

Flush T - JFT150

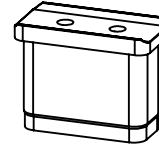

Winged T - JWT150

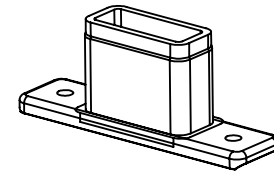

Pivot Arm (Chamfered)
JPAC150

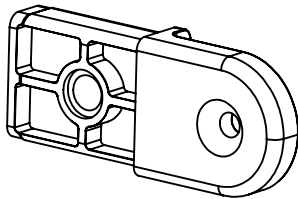

Pivot Base - JPB150

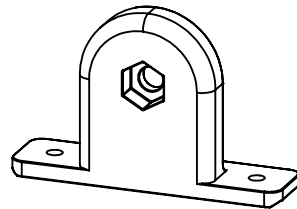

2 Way - JL2150

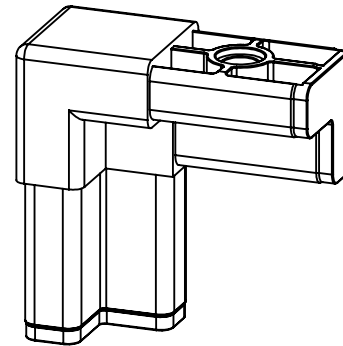

3 Way - JL3150

